

Instructions for Use

CU-SPR

The information in these Instructions for Use applies to the CU-SPR. This information is subject to change. Please contact CU Medical Systems, Inc. or its authorized representatives for information on revisions.

Revision History

Edition 1

Publication Date: July 1st, 2021

Document No.: SPR-OPM-E-01

Published by: CU Medical Systems, Inc.

Printed in the Republic of Korea

Copyright

© 2020 CU Medical Systems, Inc.

No part of these Instructions for Use may be reproduced without the permission of CU Medical Systems, Inc.

Medical Device Directive

The CU-SPR complies with the requirements of the Medical Device Directive 2007/47/EC and its revisions.



Important:

Quick defibrillation is needed if sudden cardiac arrest occurs. Since the chance of success is reduced by 7% to 10% for every minute that defibrillation is delayed, defibrillation must be performed promptly.

Contact Us

Product and Order Inquiries

Overseas Sales Team

CU Medical Systems, Inc.
130-1, Donghwagongdan-ro, Munmak-eup, Wonju-si,
Gangwon-do, Republic of Korea
Tel : +82 31 421 9700/Fax: +82 31 421 9911
E-mail addresses : admin@cu911.com

German Branch Office
CU Medical Germany GmbH, Berliner Straße 44,
10713 Berlin, Germany
Tel: +49 30 6781 7804
Fax: +49 30 6782 0901
E-mail addresses : info@cu-europe.com

Service and Technical Support

Customer Service Team

CU Medical Systems, Inc.
130-1, Donghwagongdan-ro, Munmak-eup, Wonju-si,
Gangwon-do, Republic of Korea
Tel : +82 31 421 9700/Fax: +82 31 421 9911
E-mail addresses : service@cu911.com



CU Medical Systems, Inc.

130-1, Donghwagongdan-ro, Munmak-eup, Wonju-si,
Gangwon-do, Republic of KOREA
Tel : +82 33 747 7657 Fax : +82 33 747 7659
Homepage : <http://www.cu911.com>



Medical Device Safety Service

Schiffgraben 41, 30175 Hannover, Germany

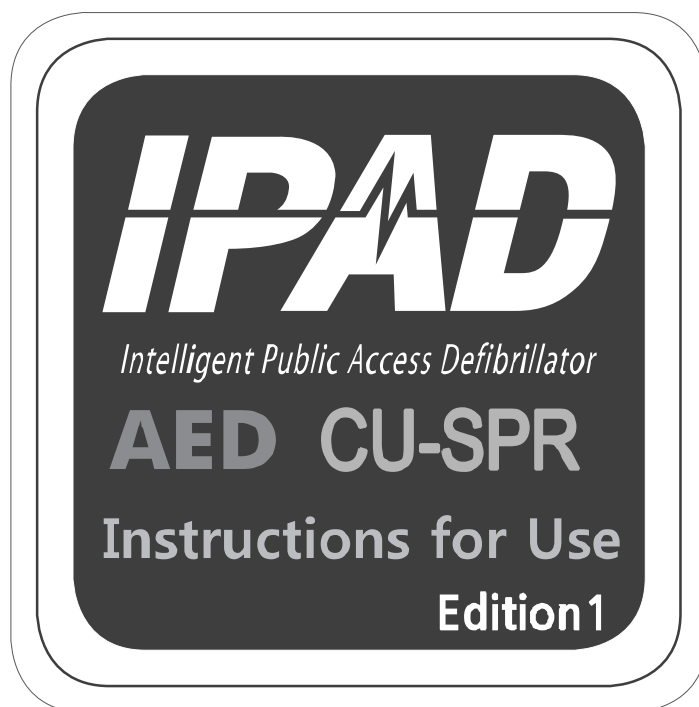

CU Medical Systems, Inc.

Table of contents

INTRODUCTION	6
OVERVIEW	7
1. INTRODUCTION	8
1.1 DEVICE DESCRIPTION	8
1.2 INDICATED USE	8
1.3 INTENDED USERS	9
1.4 LOCAL PROTOCOL	9
1.5 ADDITIONAL INFORMATION	9
2. DEVICE FEATURES	10
3. PREPARATION FOR USE	13
3.1 STANDARD PACKAGE CONTENTS	13
3.2 SETTING UP THE CU-SPR	14
4. HOW TO USE THE CU-SPR	16
4.1 CHAIN OF SURVIVAL	16
4.2 PREPARATION FOR DEFIBRILLATION	17
4.3 DEFIBRILLATION PROCEDURES FOR ADULT VICTIM	20
4.4 DEFIBRILLATION PROCEDURES FOR PEDIATRIC VICTIM	25
5. AFTER USING THE CU-SPR	27
5.1 MAINTENANCE AFTER EACH USE	27
5.2 SAVING AND TRANSFERRING TREATMENT DATA	27
5.2.1 Device Usage	27
5.2.2 Transferring Treatment Data	28
5.3 DEVICE SETTING	29
5.3.1 CPR Guide Setting	29
5.3.2 Setting the CPR Guide	29
6. MAINTENANCE	32
6.1 DEVICE STORAGE	32
6.2 MAINTENANCE	33
6.2.1 Device Inspection	33
6.2.2 Replacing Supplies	33

6.2.3	Cleaning the CU-SPR	36
7.	DISPOSAL	37
8.	TROUBLESHOOTING	38
8.1	SELF-TESTS	38
8.2	DEVICE STATUS	39
8.2.1	Status LCD.....	39
8.2.2	Status LED.....	40
8.2.3	Other indicators.....	40
8.3	TROUBLESHOOTING.....	41
8.3.1	Troubleshooting While the Device is Operating.....	41
8.3.2	Troubleshooting While the Device is not Operating(Standby Mode)	42
9.	DEVICE SERVICE.....	44
	APPENDIX	47

Introduction

These Instructions for Use contain information necessary for the correct use of this device. Please contact us regarding any questions or issues on the use of the device arising from information found in these Instructions for Use [Chapter 9: Device Service].

The company or its authorized distributor is not responsible for any injury incurred by the user or patient due to any apparent negligence or improper use by the user.

Here in after,

"Device" refers to [CU-SPR]

"We" or "Us" refers to CU Medical Systems, Inc.

"Pads" refers to defibrillation electrode pads,

"Battery Pack" refers to a disposable battery pack.

These Instructions for Use emphasize the safety procedures and precautions for the device use by using the terms below. Please acquaint yourself with the warnings, cautions and references stated in these Instructions for Use in order to safely use the device.

WARNING

- Conditions, hazards, or unsafe practices that can result in serious personal injury or loss of life.
-

CAUTION

- Conditions, hazards, or unsafe practices that can result in minor or moderate personal injury, damage to the device, or loss of treatment data stored in the device, particularly if precautionary steps are not taken.
-

NOTICE

- Used to denote items that are important during installation, operation, or maintenance of the device.
-

Overview

Thank you for purchasing the CU-SPR. This device can be effectively and safely used for a long period if you familiarize yourself with the instructions, warnings, precautions, and notices contained in these Instructions for Use prior to its use.

- You must follow the instructions, warnings, cautions, and notices in these Instructions for Use when using this device.
- The manufacturer will not be responsible for any problems involving the device that are caused by the user's negligence.
- This device shall be serviced only by the manufacturer or its authorized service centers.
- If the Device is intended to be connected to equipment other than those stated in these Instructions for Use, contact the manufacturer.
- If this Device does not operate properly, contact the manufacturer or its authorized service center.

WARNING

- A defibrillator discharges electric shocks with high voltage and current. You must be well-acquainted with the instructions, warnings, and precautions contained in these Instructions for Use.
-

1. Introduction

1.1 Device Description

CU-SPR is an easy-to-use Semi-Automated External Defibrillator (AED) that is small, light, portable, and uses a battery.

The AED automatically reads the patient's electrocardiogram (ECG) and determines if a cardiac arrest that requires defibrillation has occurred, so that both medical professionals and the general public can easily operate it. Cardiac arrest can occur anytime to anyone at any place and may threaten the patient's life if the appropriate CPR and/or electric shock with a defibrillator are not applied within a few minutes.

The CU-SPR is a semi-automated external defibrillator (AED). If connected to a patient, the CU-SPR automatically acquires and analyzes the electrocardiogram (ECG) of the patient for the presence of Ventricular Fibrillation or Ventricular Tachycardia (also known as shockable rhythms). If a shockable rhythm is detected, the device automatically charges itself. Defibrillating shock is delivered when you press the SHOCK button.

The CU-SPR is easy to use. It guides you throughout a rescue operation using voice prompts and indicators (LED and graphical indicators).

The CU-SPR is small, light, highly portable, and battery powered. It is highly suitable for use in public, out-of-hospital settings.

1.2 Indicated Use

The **CU-SPR** is indicated for use on patients that are exhibiting the symptoms of sudden cardiac arrest (SCA) with all of the following signs:

- a) No movement and no response when shaken**
- b) No normal breathing**

Do not use the CU-SPR on patients who show either of the following signs:

- a) Movement or response when shaken**
- b) Presence of normal breathing**

1.3 Intended Users

The **CU-SPR** is intended for use in or out of the hospital by emergency care personnel or healthcare professionals or laypersons. The manufacturer recommends that users train on the use of the device.

1.4 Local Protocol

Please contact your local health authority for information on the requirements of ownership and use of defibrillators.

1.5 Additional Information

Please contact CU Medical Systems, Inc. or its local distributors for any additional information on the **CU-SPR**.

2. Device Features

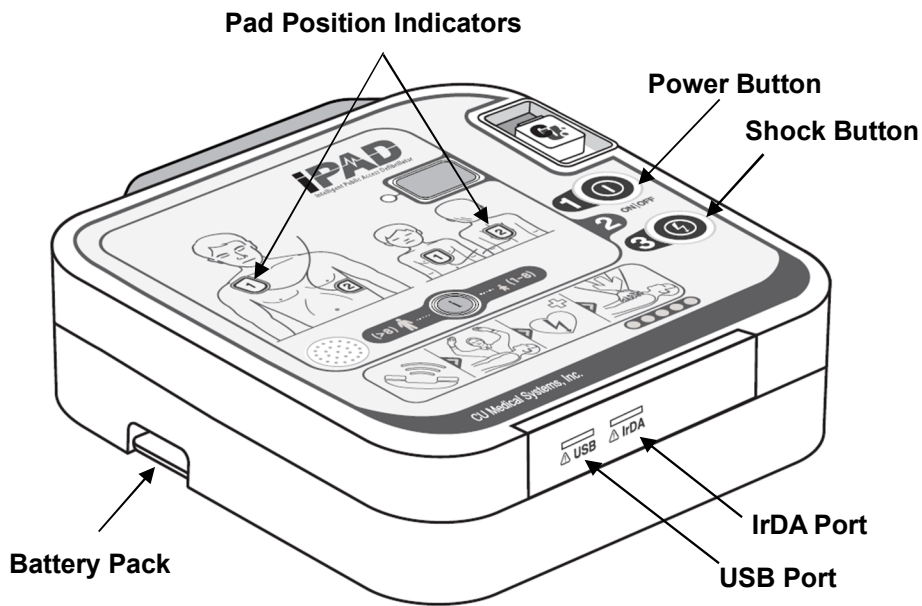
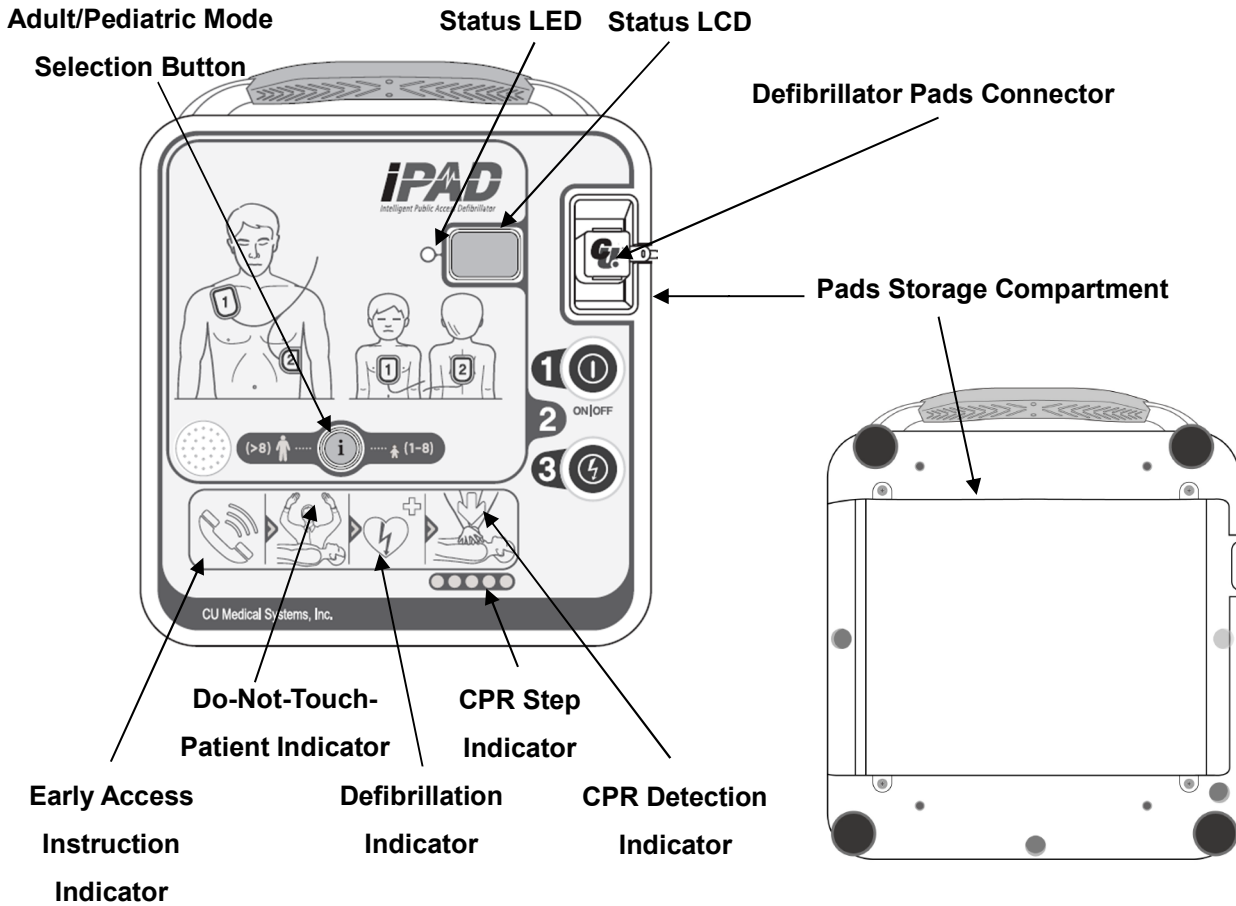

※ Pictures shown on this document may be different from the actual device and accessories.

Power Button	Turns the device on or off (When the device is on, a green LED is lit)
Status LED	Displays the current status of the device.
Status LCD	Displays the current status of the device.
Shock Button	Delivers a defibrillating shock when pressed while flashing in orange.
Adult/Pediatric mode selection button (i-Button)	Selects adult or pediatric mode.
Defibrillator Pads Connector	Connects with the connectors of the pads.
Pads Position Indicators	Indicates the pads position on the patient.
Early Access Instruction Indicator	Instructs immediate recognition of cardiac arrest and activation of the emergency response system.
Do-Not-Touch-Patient Indicator	Warns when not to touch the patient.
Defibrillation Indicator	When the defibrillation shock is needed, instructs to deliver electrical shock energy.
CPR Step Indicator	Indicates the step of CPR cycle.
CPR Detection Indicator	Indicates performance of CPR on the patient. (The indicator is lit if CPR is performed, and flashes if CPR is not performed)
Battery Pack	The disposable power source of the device.

USB Port

Port for copying device records to a USB.

**Pads Storage
Compartment**

Stores pads with removable magnetic attached cover.

3. Preparation for Use

3.1 Standard Package Contents

The following are the standard package contents of this device

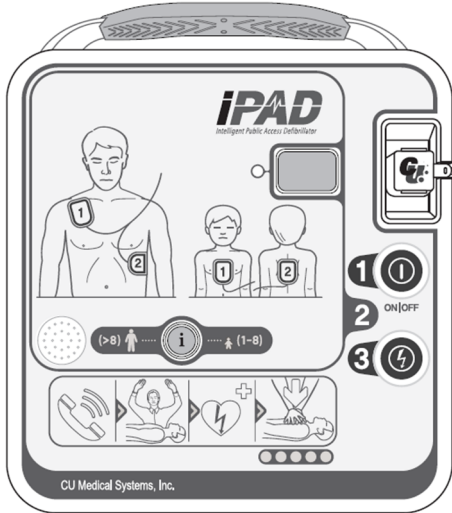

CU-SPR Semi-automated External Defibrillator



Instructions for Use

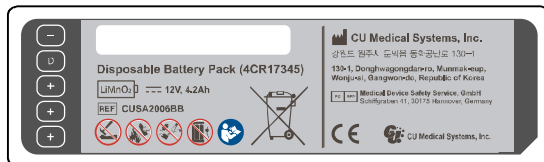

1 Battery Pack (Disposable)

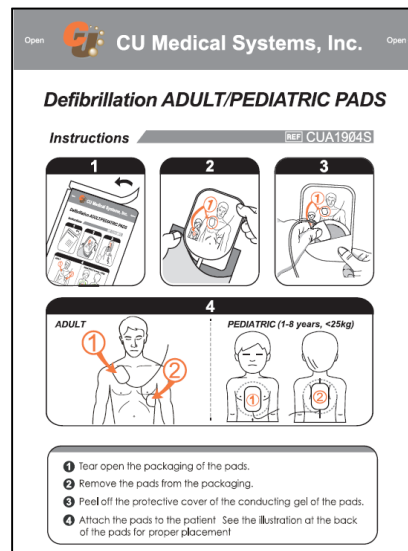

1 Pack of Adult/Pediatric Pads (Disposable)

※ Pictures shown on this document may be different from the actual device and accessories.

Please contact the manufacturer for replacement supplies (refer to [Appendix B: Parts and Accessories] of these Instructions for Use).

⚠ WARNING

- Only parts and accessories recommended and approved by CU Medical Systems, Inc. may be used with the CU-SPR.
- Using parts or accessories manufactured by a third party may compromise device safety and performance.
- Any damage, loss, or incident resulting from the use of parts or accessories that were supplied by unauthorized distributors will not be covered by CU Medical Systems, Inc.

NOTICE

- Extra battery packs and pads are recommended.

3.2 Setting up the CU-SPR

Do the following to set up the CU-SPR

- ① Open the package and verify that it contains all the items listed in the packing list.
- ② Familiarize yourself with the device features by referring to [Chapter 2: Device Features] of these Instructions for Use.
- ③ Insert the battery pack into the battery compartment of the device as shown in the figure below.

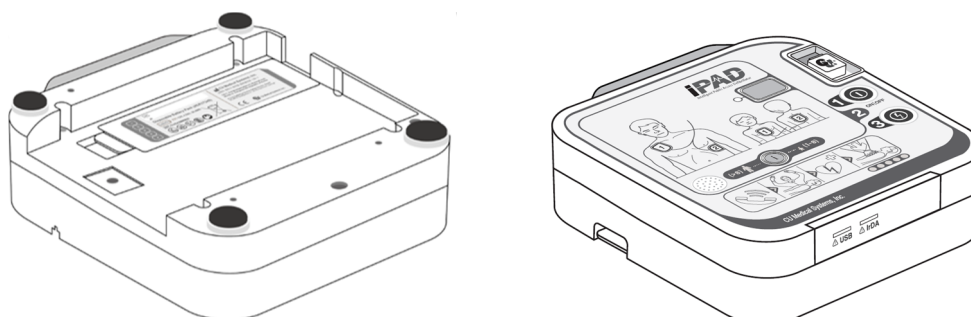

As the battery pack is inserted, a beep sounds for 1 second and the power button flashes in green, the device starts a self-test according to following process.

- Battery Level Check
- Pads Connector Connection Check
- Pads Status Check
- Button Check

To check the result of the self-test, please refer to [Chapter 8: Troubleshooting] of these Instructions for Use.

- ④ If you have a carrying case, please safely store the Device in the carrying case. If you want to purchase the carrying case, please contact us by referring to [Appendix B: Parts and Accessories] of these Instructions for Use.
- ⑤ Storage and maintenance considerations:
 - Refer to [Section 6.1: Device Storage] for proper device storage instructions.
 - When the device is in storage, check the Status LCD and LED periodically to ensure that the device is in normal condition.
 - Store the CU-SPR in accordance with your local emergency first aid protocol.
 - Store the device in an easy-to-access location where its status LCD and LED can be checked periodically and its technical alarms can be easily heard (e.g. alarm on low battery or other device problems).
 - It is also recommended to place an emergency use telephone near the device's storage area so that emergency medical services can be easily called during emergencies.
 - Store the accessories along with the device in the device's carrying case for easy and quick access.

 **WARNING**

- **Electromagnetic interference may affect the performance of the device.** While the device is in use, it should be kept away from devices that cause electromagnetic interference. Devices that may cause such interference include motors, X-ray equipment, radio transmitters, and cell phones. Refer to [Appendix F: Electromagnetic Compatibility] of these Instructions for Use for more information.
 - The use of accessories or cables other than those referred to in these Instructions for Use may increase electromagnetic radiation from the device or reduce the device's electromagnetic immunity. Only accessories and cables that are authorized by the manufacturer should be used with the CU-SPR.
-

4. How to Use the CU-SPR

4.1 Chain of Survival

If you think that you are witnessing someone go down in sudden cardiac arrest, perform the chain of actions recommended by the American Heart Association (AHA) in its Chain of Survival emergency response to sudden cardiac arrest.

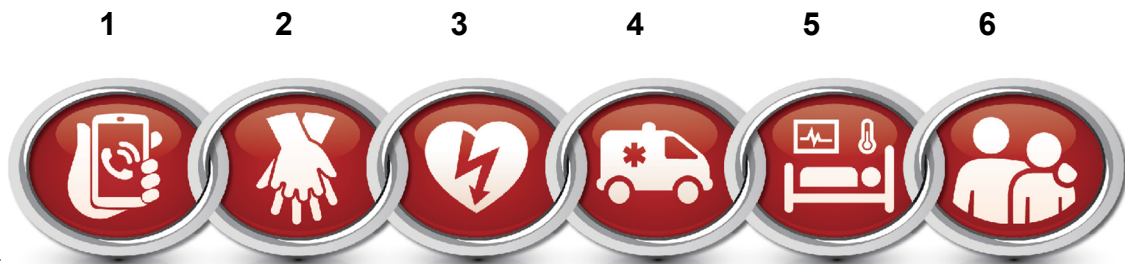

1. Activation of Emergency Response

- Check for a response by tapping the victim on the shoulder and shouting at the victim.
- Activate the community emergency response system (e.g. call 911 or the equivalent service in your locality)

2. High-Quality CPR

- Perform CPR.

3. Defibrillation.

- **Use this device (CU-SPR).**

Using this device can be summarized in 3 steps:

After pressing the Power Button,

Step 1: Place pads on the patient.

Step 2: Press the Shock Button if instructed by the device.

Step 3: Perform CPR.

4. Advanced Resuscitation.

5. Post-Cardiac Arrest Care.

6. Recovery.

NOTICE

- If finding and/or operating the defibrillator takes time, monitor the patient's status until the defibrillator is available, perform CPR if necessary.

4.2 Preparation for Defibrillation

① Turn the device on by pressing the Power Button.



When the power turns ON, the following occurs in sequence:

- The beeper will beep for 1 seconds.
- The power button has a green light.
- Self-tests are performed.
- Voice instruction: “Call emergency medical services, now”

As the power is on, self-tests following status of device are performed.

- Pads Connector Connection Check
- Adult/Pediatric Mode Check
- Check whether the pads are used
- Pads expiration date Check

To check the result of self-tests, please refer to the [chapter 8: Troubleshooting].

CAUTION

- When the device is turned on, if X is displayed on the status LCD and the device is not working, get a replacement defibrillator immediately.
- If there is no replacement device, do not delay the time to care for the patient and perform CPR as soon as possible.

② Select patient mode: Adult/Pediatric Mode

When the pads are connected to the device, the following occurs:

- Voice instruction: “Adult Mode.”

If it is need to use the device with the pediatric mode, please press the adult/pediatric mode selection button to change the patient mode.

WARNING

- If the Adult/Pediatric Mode Selection Button is pressed during the operation of the device, the defibrillation time might be delayed because the ECG analysis starts again. Therefore, it is necessary to carefully select the Adult/Pediatric Mode before using the device.

⚠ CAUTION

- When the pediatric pads are connected to the device, the Adult/Pediatric Mode selection button will not function.

③ Remove clothes from patient's chest.

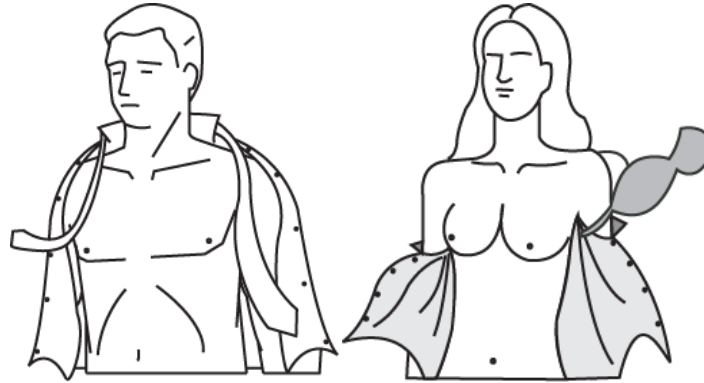

⚠ CAUTION

- Time is essential for the cardiac arrest patient. Tear or cut clothes if removing them will take time.
- Dry the patient's skin such that pads can adhere well on the chest. Shave hair on the chest if necessary.

④ Take out the pads package from the Pads Storage Compartment at the bottom of the device.

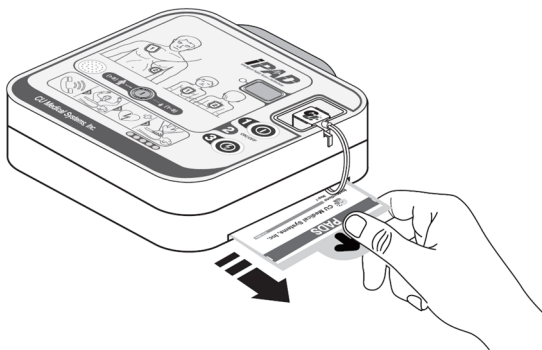

⑤ Open the pads package.



⑥ Take pads out of the pads package.



⑦ Refer to the pictures on both pads.

Adult/Pediatric Pads

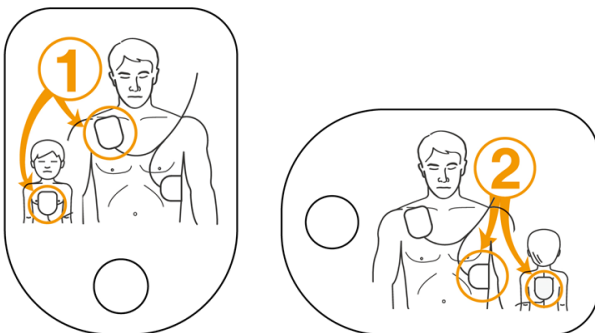

⚠ CAUTION

- The adhesive material on the pads starts to dry out as soon as the package is opened. Use immediately after opening. Refer to [Section 6.2: Maintenance] of these Instructions for Use for procedures on how to check the expiration date of the pads and pads maintenance.

4.3 Defibrillation Procedures for Adult victim

Step 1: Place pads on the patient.

- ① Peel **pad 1** off the liner, and stick the pad to the patient's upper chest as shown below.

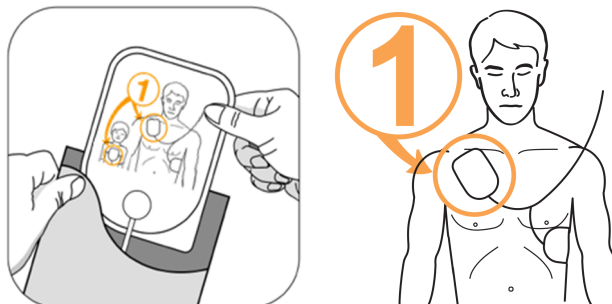

- ② Peel **pad 2** off the liner, and stick the pad to the patient's side torso as shown below.

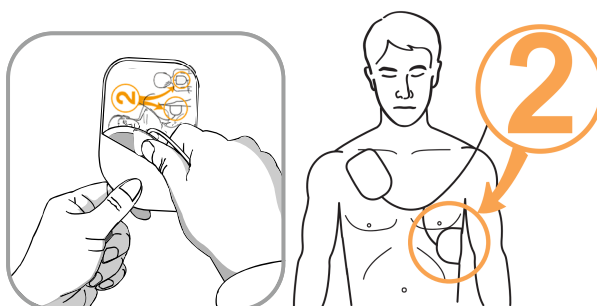

- ③ If the device detects the connection with the patient after placing the pads, the Do-Not-Touch-Patient Indicator lights. Please follow the voice instruction of the device.

If the device does not detect the patient, the device repeats the voice instructions for attaching the pads to the patient until the device detects the connection with the patient after placing the pads.

NOTICE

- In an emergency of a pediatric patient (1 to 8 years old, 10kg to 25kg), follow the Defibrillation Procedures for pediatric patients in this Instructions for Use.
- Defibrillation can be done even if the pads are reversed. If the locations of pads are switched, follow the next voice instruction without changing the directions of pads. It is more important to begin defibrillation as soon as possible.
- In the event that the pad is not adhering well, check if the adhesive side of the pads is dry. Each pad has an adhesive gel. If the gel does not adhere well, replace it with new pads.

⚠ WARNING

- Ensure the patient is not on a wet surface when performing defibrillation. If the patient's skin is wet, dry the skin prior to using the device.

Step 2: Press the Shock Button if instructed.

The device acquires and analyzes the patient's ECG immediately after being connected. The device will instruct you not to touch the patient by flashing the Do-Not-Touch-Patient Indicator and by issuing the voice prompt: "Do not touch the patient, analyzing heart rhythm". After analyzing the ECG, the device will determine whether or not the patient needs defibrillation.

⚠ WARNING

- Do not move or touch the patient during ECG analysis. Contact with the patient while analyzing the patient's ECG may result in errors in the ECG analysis.

If the patient needs defibrillation, the device will do the following:

The device announces that a defibrillation shock is needed, and instructs you to keep away from the patient.

⚠ CAUTION

- While the device is charging after a shockable rhythm is detected, the ECG of the patient is continuously acquired and analyzed. The device disarms itself if the ECG rhythm changes to a non-shockable rhythm before shock delivery.

When it is charged, the device activates the following indicators in sequence:



The device informs you that an electric shock is needed and instructs you to stay away from the patient.

- Continuously beep while the Shock Button flashes in orange.
- The device instructs you to press the flashing orange Shock button.

You should press the Shock Button within 15 seconds.

When the Shock Button is pressed, the device delivers a defibrillating shock to the patient. If defibrillation is properly done, the device reports that an electric shock has been delivered.

After shock delivery, the device indicates that you may touch the patient, and the CPR Mode Indicator is lit. Then, the voice instruction for CPR starts.

If the flashing Shock Button is not pressed within 15 seconds, the device operates as follows:

- Voice instructions: “Shock button is not pressed.”
- The light of shock button off
- Internal discharge

Then, the device instructs to perform CPR.

 **WARNING**

- Do not touch (you or anybody else) the patient during shock delivery.
 - Before defibrillation, make sure that there is no contact between 1 and 2 below which may provide unwanted pathways for the defibrillating current.
 1. the patient’s body (such as exposed skin or head or limbs), conductive fluids (such as gel), blood, or saline
 2. metal objects (such as bed frame or stretcher)
-

 **CAUTION**

- While analyzing ECG, keep the patient still and minimize movements around the patient. Do not touch the patient and pads while the Do-Not-Touch-Patient Indicator is on. Electrical noise (interference) may delay the ECG analysis.
 - As a safety measure, the device will not deliver a shock until the flashing orange SHOCK button is pressed. If the SHOCK button is not pressed within 15 seconds of the voice instruction to press the SHOCK button, the device will disarm itself (dumps the shock energy in its internal load) and will instruct you to make sure that emergency medical services have been called. The device will then instruct you to begin CPR.
 - During defibrillation, disconnect other medical electrical equipment which has no defibrillation-proof applied parts from the patient.
 - If the device malfunctions during a rescue operation, it will instruct you to get a replacement defibrillator and will start the voice instruction for CPR. Have CPR performed until the replacement defibrillator is ready to use.
-

If the patient does not need defibrillation, the device will do the following in sequence:

- The device announces that the patient does not need a defibrillating shock and that you may touch the patient.
- The CPR step and detection Indicator is lit.
- Voice instruction for CPR starts.

Step 3: Perform CPR.

Perform CPR when the CU-SPR instructs you to do so.

By default, the CU-SPR gives voice instruction for CPR during pause for CPR after a shock delivery.

If the device detects the CPR, the device operates following:

- Voice instructions: “Continue chest compressions”
- CPR Detection Indicator lights.

⚠ CAUTION

- If the device does not detect the CPR, the device operates as follows:
 - Voice instructions: “Do CPR, now.”
 - CPR Detection Indicator flashes.

For details on CPR, See below.

[CPR Method]

1. Compression Point

Place the heel of your hand in the middle of the patient's chest between the nipples (which is the lower half of the sternum), and put the heel of your other hand on top of the first so that your hands are overlapped and parallel.

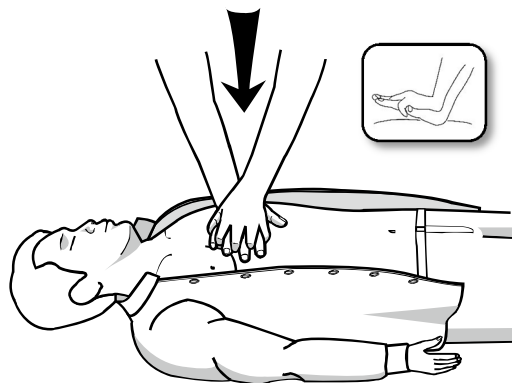

2. Compression Speed and Depth

Compress the chest at least 5 cm deep, and at a rate of at least 100~120 compressions per minute.

Adult victims: Perform chest compression at a rate of 100 to 120/min and to at least 2 inches (5 cm) for an average adult, while avoiding excessive chest compression depths (no more than 2.4 inches [6 cm]).

Pediatric victims: For infants and children, it is reasonable for rescuers to provide chest compressions that depress the chest at least one third the anterior-posterior diameter of the chest, which equates to approximately 1.5 inches (4 cm) in infants to 2 inches (5 cm) in children. Once children have reached puberty, it is reasonable to use the adult compression depth of at least 5 cm but no more than 6 cm.

3. Opening the Airway

While lifting the patient's chin up, tilt the head backward to open the airway.

4. Ventilation Method

Pinch the patient's nose as shown in the figure below, and give the patient enough breaths to make the chest rise significantly.

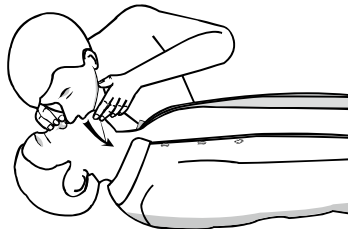

⚠ CAUTION

- While playing the CPR guide, the device does not analyze the patient's ECG. After the CPR guide, the device automatically starts the reanalysis of the patient's ECG.

NOTICE

- If you have not been trained in CPR, you should perform only chest compression or follow the instructions of the emergency medical services' agent on the phone.
- If you are trained for CPR and able to perform ventilation, perform the chest compression along with ventilation.

4.4 Defibrillation Procedures for pediatric victim

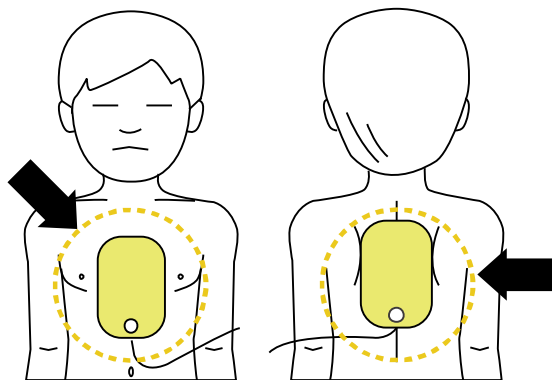

When the patient (older than 1 year and younger than 8 years, more than 10 kg and less than 25 kg) is pediatric, defibrillation can be done using the pediatric pads. When the pediatric pads are connected to the device, the device is set automatically with the pediatric mode regardless of the setting of the adult/pediatric mode selection button.

When the device is in pediatric mode,

- The pediatric pads are connected to the device.
- The adult/pediatric mode selection button is set in pediatric mode with using the adult/pediatric pads.

CU-SPR automatically sets the defibrillation energy to 50J and provides pediatric CPR guide.

Place pads on the middle of the chest and back as illustrated above. Pads are not specific to either chest or back.

⚠ WARNING

- Do not use pediatric pads for an adult patient (more than 25kg or 8 years old)

⚠ CAUTION

- The electric shock energy is automatically changed to adult mode(150/200J) for adult pads and pediatric mode (50J) for pediatric pads. For a quick care, it is recommended to check the correct pads before attaching the pads.
-

If the device has recognized the pediatric patient, please use the device according to the voice instructions.

If you are not sure of the exact weight or age, DO NOT DELAY TREATMENT,

- Set the adult/pediatric mode selection button in adult mode using the adult/pediatric pads.

NOTICE

- Follow the instructions below when giving first aid during pediatric cardiac arrest.
 - When giving first aid during a pediatric cardiac arrest, ask others to call the emergency medical center and to bring the CU-SPR while you are performing pediatric CPR.
 - When there is no one else around, perform CPR for 1 to 2 minutes, call emergency medical services, and then get the CU-SPR.
 - If you witnessed the child's collapse, call emergency medical services immediately, and then get the CU-SPR.
-

5. After Using the CU-SPR

5.1 Maintenance After Each Use

- Check the device for signs of damage and contamination.
- If there is dirt contamination, see [Section 6.2.3 on how to clean the device.]
- Run a battery insertion test. Refer to Section [8.1: Self-Tests] for the procedure.
 - If  is displayed on the Status LCD after running the test, the device status is normal.
- Dispose of the used pads properly. Place a new pouch of defibrillator pads into the pads storage compartment. See to it that the pads are not beyond their expiration date.

The CU-SPR uses disposable pads. Do not reuse them. Refer to Section [6.2.2: Replacing Supplies] on how to replace the pads.

WARNING

- You should use only the defibrillator pads provided and recommended by the manufacturer.
 - Do not open the pads package until immediately before use. Since the adhesive material on the pads starts to dry out as soon as the package is opened, the pads may not be usable regardless of the expiration date.
 - CU Medical Systems, Inc. will not be responsible for any damage, loss, or incident resulting from the re-use of defibrillator pads.
-

5.2 Saving and Transferring Treatment Data

5.2.1 Device Usage

This device automatically saves the following treatment data:

- ECG data
- Usage information

The treatment data is automatically recorded in the internal memory. This data is not erased even if the device is turned off. The recorded treatment data may be copied by USB media.

⚠ CAUTION

- The CU-SPR keeps the data of the 5 most recent treatment operations and can save up to 3 hours of ECG data for each rescue operation. ECG data beyond 3 hours will not be recorded.
- When the device is used more than 5 times, it deletes the oldest treatment data to make room for data from a new treatment operation. It is recommended to archive treatment data after each use of the device.
- If the battery pack is removed while the device is operating, treatment data cannot be properly recorded. If you wish to remove the battery pack, turn the power off by pressing the Power Button before removing the battery pack.

5.2.2 Transferring Treatment Data

The treatment data may be copied via a USB. The entire treatment data of all patients that is recorded on the device is transferred using only the USB method

1. Copying Treatment Data by Using the USB

- ① Insert USB to the USB port in the device.
- ② When the adult/pediatric mode selection button (i-button) is pressed for more than 1 second in standby mode, the mode changes into administrator mode with voice guide.

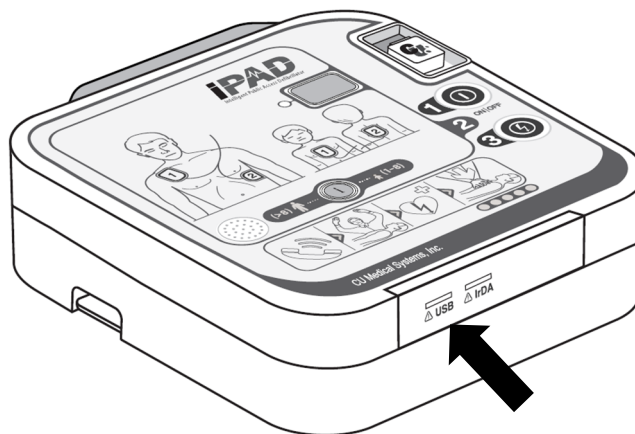

If there is treatment data in the device's internal memory:

- The device informs you the number of treatment data with voice instructions. Then, the device starts the copying of the treatment data onto the USB with the voice of starting copy.
- When the copying of the treatment data is completed, the device automatically turns off after a beep sounds once.

If there is no treatment data in the device's internal memory:

- The device informs you that there are no treatment data with voice instructions.

NOTICE

- If the treatment data is not transferred to the USB, a beep sounds 3 times and the power is turned off.
 - USB storage supports FAT32 format.
 - Please use the USB guaranteed by our company. If you use a USB that is not provided by our company, we cannot guarantee proper data transfer.
-

Please contact CU Medical Systems, Inc. or its authorized representatives for more information about transferring treatment data.

5.3 Device Setting

5.3.1 CPR Guide Setting

The default CPR setting of CU-SPR is 5 cycles with 30 chest compressions and 2 breaths in accordance with the American Heart Association (AHA) 2020 CPR Guidelines. However, you may customize these.

You can set the following:

- Number of chest compressions
- Number of ventilation
- Number of cycles
- Number of chest compressions per minute
- Detailed guide selection

5.3.2 Setting the CPR Guide

- ① When the Shock Button and Adult/Pediatric Mode Selection Button (i-Button) are pressed for at least 1 second in standby mode, the mode changes into administrator mode with a voice guide.
- ② The device gives a summary (the total hours of the last device use and the number of electric shocks).
- ③ When instructed to set the CPR guide, press the Adult/Pediatric Mode Selection Button (i-Button) to enter the CPR guide setting mode.

- ④ When instructed to enter a password, enter the set password.

NOTICE

- Password: press the following buttons in sequence:

Adult/Pediatric Mode Selection Button (i-Button) → Adult/Pediatric Mode Selection Button (i-Button) → Shock Button → Adult/Pediatric Mode Selection Button (i-Button) → Shock Button → Shock Button

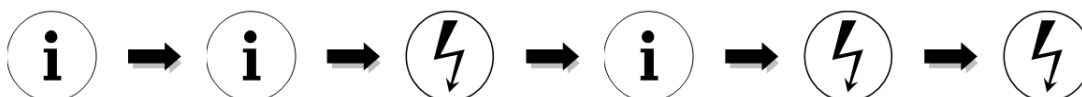

- ⑤ The voice will give information regarding the current CPR guide setting.
- ⑥ Press the Shock Button to change the setting, or press the Adult/Pediatric Mode Selection Button (i-Button) to proceed to the next step.
- ⑦ Settings can then be changed in the following order: Number of Chest Compressions, Number of Ventilations, Chest Compression rate, Pausing Time, and Detailed Guide Selection. Refer to [Table 1] CPR Guide Setting Options below.
- ⑧ When the setting is completed, the voice guide will give information regarding the set CPR guide, which may be saved or canceled.
- ⑨ Press the Adult/Pediatric Mode Selection Button (i-Button) to save or the Shock-Button to cancel according to voice instructions.
- ⑩ When the CPR guide setting is either saved or canceled, the device automatically shuts down.

[Table 1] CPR Guide Settings Options

Number	Setting Option	Range	Unit	Default	Description
1	Number of Chest Compression	15, 30	15	30	Perform 30 compressions.
2	Number of Ventilations	0 to 2	1	2	Give 2 breaths.
3	Number of Cycles	2 to 10	1	5	Perform 5 cycles of chest compression and ventilation.
4	Chest Compression	100 to 120	5	100	Compress the chest at a rate of 100 compressions per minute.

Rate					
5	CPR Pause time	30 to 180 sec.	30 sec.	120sec.	Pause for 120 seconds (2 minutes).
6	Detailed Guide Selection	On/Off	-	On	Turns ON or OFF detailed voice instructions for the chest compression and ventilation when performing CPR.

NOTICE

- If the Detailed Guide Selection is OFF and the Number of ventilations is set to 0, the CU-SPR provides only chest compression guidance for 2 minutes. After 2 minutes, the CU-SPR automatically reanalyzes the patient's ECG.
- The CPR Chest Compression Rate can only be set in Pediatric mode. In Adult mode, the chest compression rate is fixed at 30 regardless of the set chest compression rate.
- Default CPR guidance settings and functions can vary according to customer preference. CPR settings include voice guidance options, mute function, and chest compression options.

6. Maintenance

6.1 Device Storage

Please refer to the precautions below when storing the Device in order to avoid device damage.

- Do not operate or store the device in conditions that are beyond the following specified limits.

- **Storage Conditions**

The device is stored together with the defibrillator pads and the battery pack is inserted - ready to be used in an emergency

Temperature: 0°C ~ 50°C (32°F ~ 122°F)

Humidity: 5% ~ 95% (non-condensing)

- **Transport Environment**

device only, no defibrillator pads and battery pack included

Temperature: -20°C ~ 60°C (-4°F ~ 140°F)

Humidity: 5% ~ 95% (a location with no condensation)

- Do not store the device in areas that are directly exposed to sunlight.
- Do not store the device in areas with highly fluctuating temperatures.
- Do not store the device near heating equipment.
- Do not store the device in areas where there is high vibration (in excess of Road Transportation and Helicopter Minimum Integrity of MIL-STD-810G Method 514.5C).
- Do not operate or store the device in environments with high concentration of flammable gas or anesthetics.
- Do not operate or store the device in areas with high concentration of dust.
- Only personnel authorized by the manufacturer may open the device for servicing. There are no user serviceable components inside the device.
- Any attempts to open the device without authorization will result in immediately nullifying the warranty regardless of the warranty period.
- CU Medical Systems, Inc. will not be responsible for any damage, loss, or incident resulting from the use of a device that has been opened by unauthorized personnel.

6.2 Maintenance

6.2.1 Device Inspection

The CU-SPR has self-testing capability. The device performs a self-test as soon as the battery is inserted, turns itself off when the test is done, and periodically wakes up to perform the daily, weekly, and monthly self-tests. To initiate a battery insertion self-test, remove the battery pack and reinsert. Refer to [Section 8.1: Self-Tests] for more information.

CAUTION

- Inspect the CU-SPR daily to ensure that it is always ready for an emergency. Check the current status of the device, battery, and pads as displayed on the Status LCD and LED.
 - Refer to [Section 8.2: Device Status] for information regarding the Status LCD and LED
-

6.2.2 Replacing Supplies

When the device is in storage, check the battery level indicator and the pads status on the Status LCD and LED daily to ensure that the device is always ready for an emergency. Replace the battery pack or the defibrillator pads when it is depleted or when they go beyond their expiration date, respectively.

Disposable Battery Pack

Replacement of the Disposable Battery Pack

- Replace the battery pack when it becomes depleted. Refer to [Chapter 8: Troubleshooting] on how to check the battery status.
- Dispose of depleted battery packs in accordance with local environmental regulations.
- Use only the battery packs recommended and provided by the manufacturer.
- The battery pack is disposable. Do not recharge.

Replacing the Disposable Battery Pack

1. Remove the discharged battery pack by pulling it out while pressing the lock on the bottom of the device. Refer to the figure below.

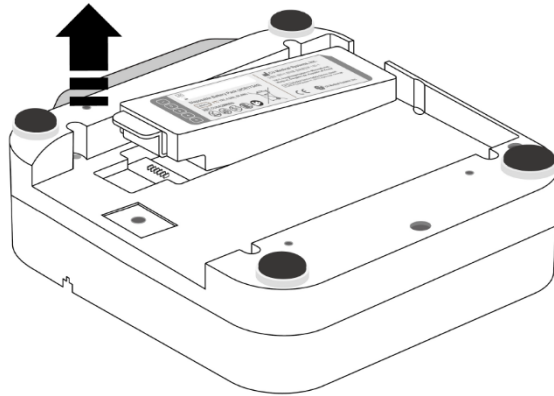

2. Insert a new battery pack in the direction of the arrow with the label facing upward as shown in the figure below.

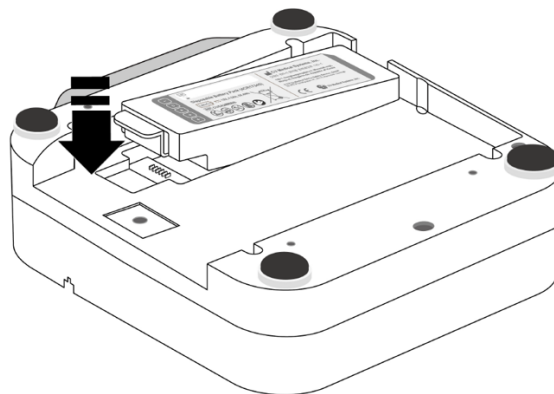

3. Push the battery pack until you hear it click into place.

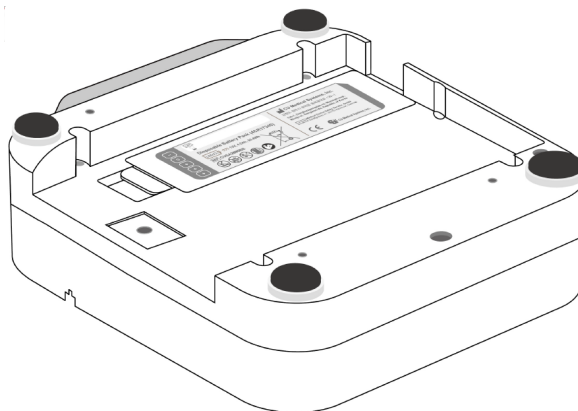

⚠ CAUTION

• Battery Pack Precautions

- Do not subject the battery pack to serious physical impact.
- Do not attempt to open or break apart the battery pack.
- Do not let the battery pack come into contact with open flames or hot objects.
- Do not short-circuit the terminals of the battery pack.
- Keep out of the reach of children.
- If any leakage gets in the eye, immediately clean the eye with water and consult with a doctor.
- Do not store the battery pack under direct sunlight.
- Do not store the battery pack in a wet or very humid place.
- Comply with local regulations when disposing of the battery pack.
- Do not destroy or incinerate the battery pack.
- Never attempt to recharge the disposable battery pack.

Replacing the Pads

- **Check the pads status on the Status LCD and LED daily.** Do not use pads that are beyond the expiration date.
- Check the pads package for damage.
- Check the cable outside the packaging pouch for possible defects.
- Only pads provided by the manufacturer should be used with the CU-SPR.

Replacing Pads

1. Check the expiration date of the pads. Refer to the figure below for checking the expiration date.



The expiration date is marked to the left of the “Multifunction Defibrillation ADULT PADS” label on the pads package.

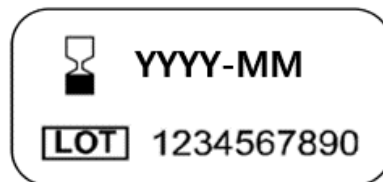

The expiration date is marked as follows:

YYYY-MM
YYYY – Year
MM – Month

2. Used or expired pads should be replaced. Hold the top and bottom of the pads connector with your fingers, pull it out, and take the pads out from the Pads Storage Compartment as illustrated below.

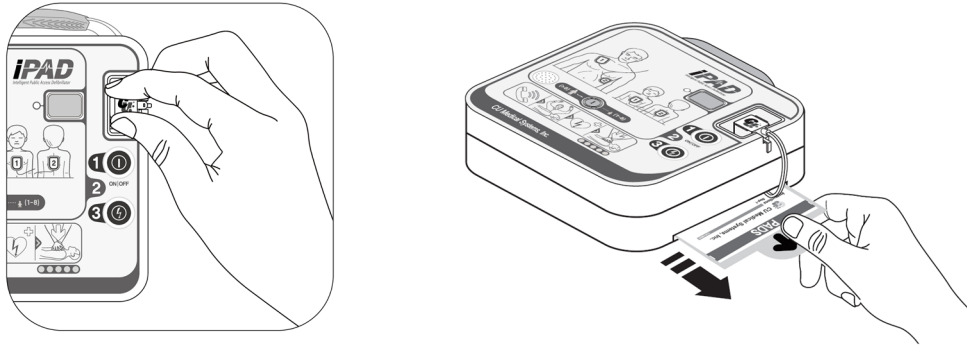

3. Insert the pads connector of the new pads into the Defibrillator Pads Connector and then put the pads package in the Pads Storage Compartment as illustrated below.

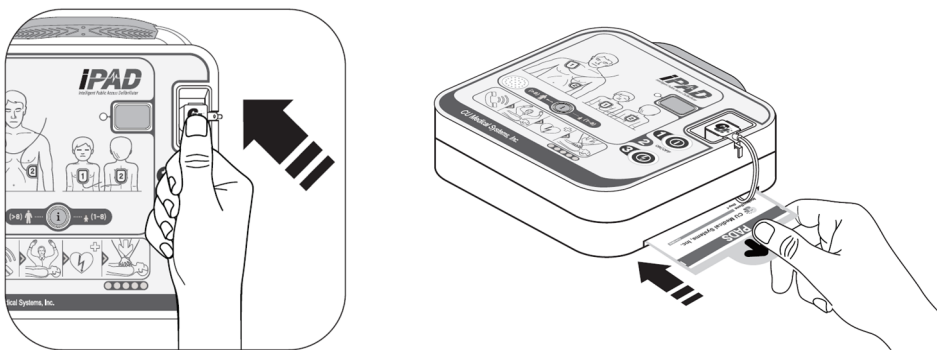

6.2.3 Cleaning the CU-SPR

Clean the device with a soft cloth. The following detergents may be used to clean the exterior of the device:

- Dilute soap and water
- Dilute chlorine bleach (dilute 30 ml of chlorine bleach in one liter of water)
- Dilute ammonia-based cleaners
- Dilute hydrogen peroxide

 CAUTION

- If expired pads or used pads is connected, change pads with the new one. Not proper pads connection alarm can lead early battery depletion.
 - Do not immerse the device or its accessories in liquids.
 - Be careful not to allow any liquids to get into the device.
 - If the device is immersed in liquids, immediately contact the manufacturer or its authorized service center.
 - Giving excessive force or shock while cleaning the device may cause damage.
 - Do not use an acetone-based strong detergent or abrasive when cleaning the device.
 - Do not use a detergent containing abrasive ingredients.
 - Do not sterilize the CU-SPR.
-



7. Disposal

Dispose of CU-SPR and its accessories in accordance with local regulations.

8. Troubleshooting

8.1 Self-Tests

The following table lists self-tests done by the device.

Self-Test Type	Description
Battery Insertion Test	<p>Runs when the battery pack is inserted into the device.</p> <p>Perform this test:</p> <ul style="list-style-type: none"> • Before the device is deployed • After each use • When replacing the battery • When the device is suspected to be damaged <p>CAUTION</p> <p>Do not run this test when you are about to use the device to treat a sudden cardiac arrest victim because this test takes time (around 20 seconds).</p> <p>If a new battery pack is inserted just before a treatment, do the following to cancel this test:</p> <ul style="list-style-type: none"> • Press the Power Button. • Wait for the device to turn OFF. • Press the Power Button again to turn the device ON. <p>Aside from testing its internal systems, the device also tests the following during this self-test:</p> <ul style="list-style-type: none"> • Shock Button and Adult/pediatric mode selection button– press the buttons one by one when instructed • Defibrillator pads status – the device tests the connection status (whether connected or not) and the expiration date of the defibrillator pads. <p>If no error is detected, will  be displayed on the Status LCD.</p> <p>If an error is detected,  will be displayed on the Status LCD and the Status LED is flashing red.</p>
Self-Test Type	Description
Power ON Test	<p>The device performs a self-diagnostic test when the Power Button is pressed</p>

Run-time Test	The device monitors itself in real-time during its operation.
Periodic Self-Diagnostic Test	This device performs self-diagnostic tests daily, weekly and monthly. The periodic self-test checks important features of the device such as the battery status, pads status and internal circuits.

If the device fails to perform any self-test during use and is unable to defibrillate, it will instruct you to replace the device and start the voice instruction for CPR. In order to check the error in the device, please check the Status of LCD and LED in the device. For more information, please refer to the [8.3 Troubleshooting].











⚠ CAUTION

- It is recommended to run the battery insertion test only during the times enumerated in the table above. The battery insertion test consumes battery power and will shorten battery life if done more frequently than necessary.

8.2 Device Status

The status of the device is indicated by the following:

8.2.1 Status LCD

Indicator		Meaning	Remark
Status LCD Device Operation		The device is functioning normally.	
Status LCD Device Operation		The device has an error.	
Status LCD Battery Level Indicator		The battery is fully charged.	
Status LCD Battery Level Indicator		Less than half battery power remains.	
Status LCD Battery Level Indicator		Less than quarter battery power remains.	
The battery symbol in Status LCD blinks.		Less than 15% of battery power remains.	
Status LCD Battery Level Indicator		Battery is low.	
Status LCD Pads Status		The expiration date of the pads is more than 3 months.	
Status LCD Pads Status		The pads will expire within 3 months.	
Status LCD Pads Status		The pads are used or expired.	

8.2.2 Status LED

Indicator	Meaning	Remark
Green light	The device is functioning normally.	
Yellow light	Recommended replacing the battery with a new battery. The pads will expire within 3 month.	
Red light	System Error	
	Low Battery	
	The pads are expired.	
	The pads are used.	
	The pads have a problem.	
	The pads connector is disconnected.	

8.2.3 Other indicators





Indicator	Meaning	Remark
Do-Not-Touch-Patient Indicator: Off	You may touch the patient.	
Do-Not-Touch-Patient Indicator: Light	You may not touch the patient.	
CPR Step and Detection Indicator: Light	CPR is being performed.	
CPR Step and Detection Indicator: Flashing	CPR is not performed or not properly performed.	
Shock Button: Flashing in Orange	The device is ready to deliver a defibrillating shock. Press the Shock Button to deliver a shock.	

8.3 Troubleshooting

The device informs you of its current status or of problems via status indicators, beeps, and/or voice instruction. Refer to the following for details:

8.3.1 Troubleshooting While the Device is Operating

8.3.1.1 Status LCD

Indicator		Meaning	Solution
Status LCD Device Operation		An error has occurred in the device.	Immediately replace the defibrillator and perform CPR if appropriate.
The battery symbol in Status LCD blink		Less than 15% of battery power remains.	Recommend replacing the battery with a new one.
Status LCD Battery Level Indicator		The battery is low.	Replace the battery with a new one.
Status LCD Pads Status		The pads is expired. The pads has been used.	Replace the pads with a new one.

8.3.1.2 Status LED

Indicator	Meaning	Solution
Red light is lit	System Error	Immediately replace the defibrillator and perform CPR if appropriate.
	Low Battery	Replace the battery with a new one.
	The pads is expired. The pads is used.	Replace the pads with a new one.
	The pads have a problem.	
	The pads connector is disconnected.	Ensure the Pads Connector is properly connected.

8.3.1.3 Voice Prompts





Indicator	Meaning	Solution
Voice Prompt : “Low battery”, “Replace the battery with a new one.”	The battery is low.	Replace the battery with a new one.
Voice Prompt : “Plug the pads connector into the device.”	The Pads Connector is disconnected	Ensure the Pads Connector is properly connected.
Voice Prompt : “Used pads”, “Replace the pads with a new	The pads has been previously used.	Replace the pads with a new one.

one”		
Voice Prompt : “The pads are beyond their expiration date”, “Replace the pads with a new one”	The pads has expired.	Replace the pads with a new one.
Voice Prompt : “Press the pads firmly to the bare skin of the patient”	The pads is not properly attached to the patient's skin.	Check if the pads is securely attached to the patient's skin.
Voice Prompt : “No shock delivered”	The pads is not properly adhering to the patient's skin.	Press the pads firmly to the patient's skin. Shave chest hair or wipe off moisture if necessary before attaching the pads.

- If the problem cannot be solved during an emergency, you should follow the following steps:
 - ① Quickly replace the defibrillator if possible.
 - ② If no replacement device is available, check the patient's condition and perform CPR as necessary. Continuously check the patient's condition and perform CPR until the emergency medical services arrives.

8.3.2 Troubleshooting While the Device is not Operating(Standby Mode)

8.3.2.1 Status LCD

Status LED		Meaning	Solution
Status LCD Device Operation		System error	Immediately replace the defibrillator and perform CPR if appropriate.
The battery symbol in Status LCD blinks.		Less than 15% of battery power remains.	Recommend replacing the battery with a new one.
Status LCD Battery Level Indicator		The battery is low.	Replace the battery with a new one.
Status LCD Pads Status		The pads is expired. The pads has been used.	Replace the pads with a new one.

8.3.1.2 Status LED

Indicator	Meaning	Solution
Red light flashing	System Error	Immediately replace the defibrillator and perform CPR if appropriate.
	Low Battery	Replace the battery with a new one.
	The pads is expired. The pads is used.	Replace the pads with a new one.
	The pads have a problem.	

	The pads connector is disconnected.	Ensure the Pads Connector is properly connected.
--	-------------------------------------	--

- If the problem is not resolved or if no replacement battery is available, contact the manufacturer (refer to [Chapter 9: Device Service])

9. Device Service

Device Warranty

Device Name		Model Name	
Purchase Name		Serial No.	
Distributor		Person in Charge	

- This device is warranted by CU Medical Systems, Inc. against defects in materials and workmanship for 5 years from the date of original purchase. During the warranty period, we will repair or, at our option, replace at no charge a device that proves to be defective, provided you return the device, shipping prepaid, to us or to our authorized representative.
- This warranty does not apply if the device has been damaged by accident or misuse or as the result of service or modification by entities other than CU Medical Systems, Inc. or its authorized representatives. IN NO EVENT SHALL CU MEDICAL SYSTEMS BE LIABLE FOR CONSEQUENTIAL DAMAGES.
- Only devices with serial numbers and their accessories are covered under this warranty. PHYSICAL DAMAGE CAUSED BY MISUSE OR PHYSICAL ABUSE IS NOT COVERED UNDER THE WARRANTY. Items such as cables and modules without serial numbers are not covered under this warranty.

Battery Shelf Life

- The battery shelf life is up to 5 years from the date of manufacture when stored according to the instructions in this document and without having been inserted into the device.
- Battery degradation may occur after 3 years of storage, possibly shortening the standby life of the battery pack.

Standby Life (i.e. after inserting the battery pack)

- If the battery pack is stored and maintained according to the instructions in this document and not used, a long-life battery pack will last up to 5 years in standby mode. A standard battery pack will last up to 2 years. The standby lifespan begins from the initial insertion into the device.
- When the device is turned on, the standby lifespan of the battery pack will decrease in accordance with the history of use.

Warranty for the Battery Pack

- The battery pack warranty will be honored according to the date of manufacture or the purchase date shown on the invoice. The long-life battery pack warranty is 5 years, and the standard battery pack warranty is 2 years.

For other warranties that are not specified or appear to be unclear in this document, such as partial warranty, contact us.

Warranty Disclaimer

The following renders this warranty null and void:

- Servicing by unauthorized personnel.
- If the factory seal is broken without proper authorization from CU Medical Systems, Inc.
- Failure or damage caused by a fall or external shock after purchase
- Damage by natural disasters such as fire, earthquake, flood and/or lightning
- Failure or damage by environmental pollution or abnormal voltage
- Damage caused by storage in conditions beyond the specified limits.
- Failure due to depletion of consumables
- Failure caused by sand and/or soil getting inside the device
- The purchase date, customer name, distributor name, batch number and other listed information being arbitrarily changed
- No proof of purchase provided along with the device warranty
- Usage of accessories and parts not recommended by the manufacturer.
- Other failure or damage caused by inappropriate operation.

Service

- The CU-SPR must be serviced only by authorized personnel.
- The CU-SPR will be serviced free of charge during the warranty period. After the warranty period, the cost of material and service shall be shouldered by the user.
- When the CU-SPR is not operating properly, immediately bring it for servicing to an authorized service center.
- Please fill out the following table with the necessary information when requesting for service.

Device classification		Semi-Automated External Defibrillator	
Device Name		Model Number	CU-SPR
Serial Number		Date of Purchase	
Sales Representative			
User Information	Name		
	Address		
	Contact no.		
Brief description of the problem			

Appendix

A . Rescue Protocol

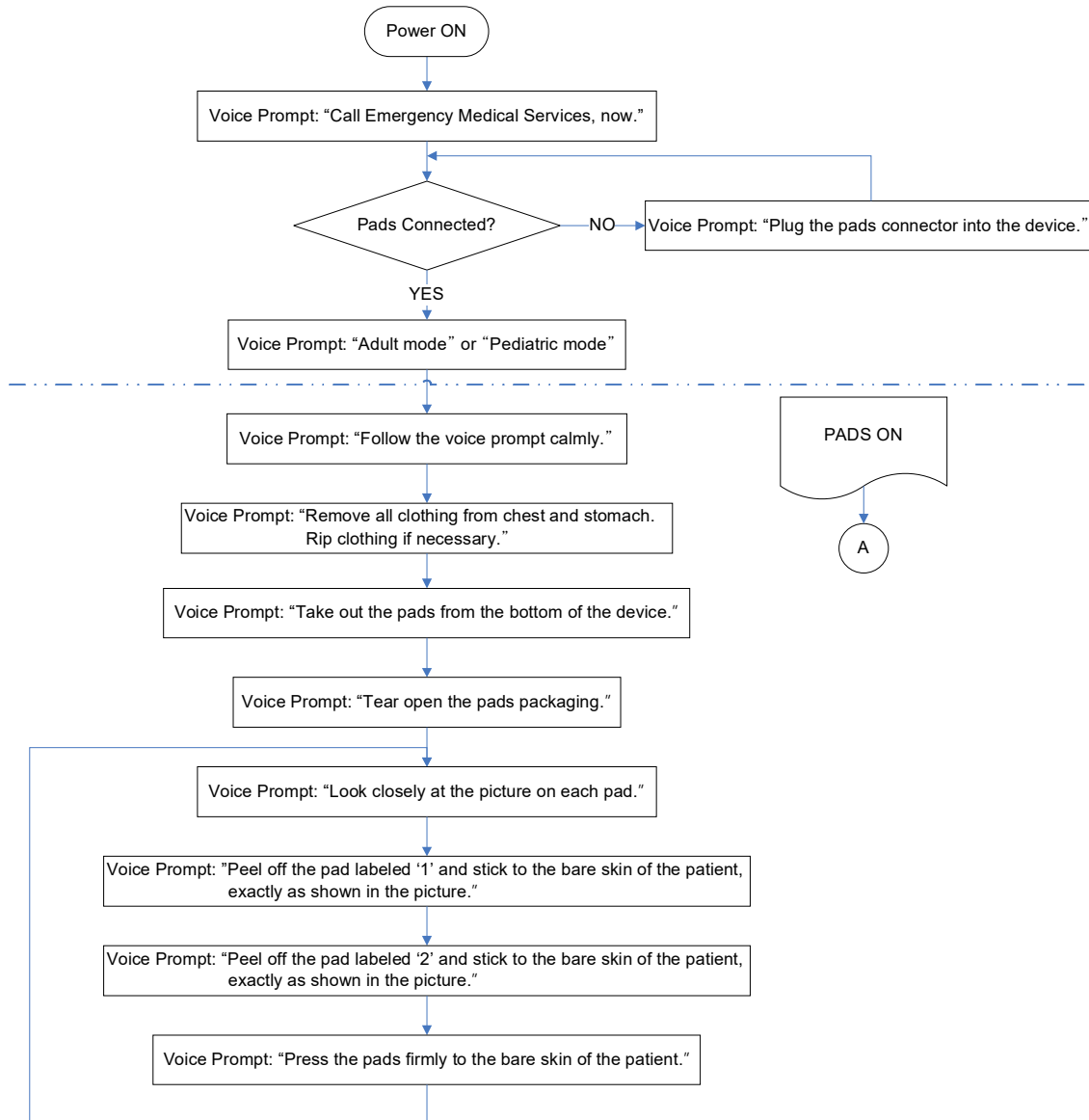

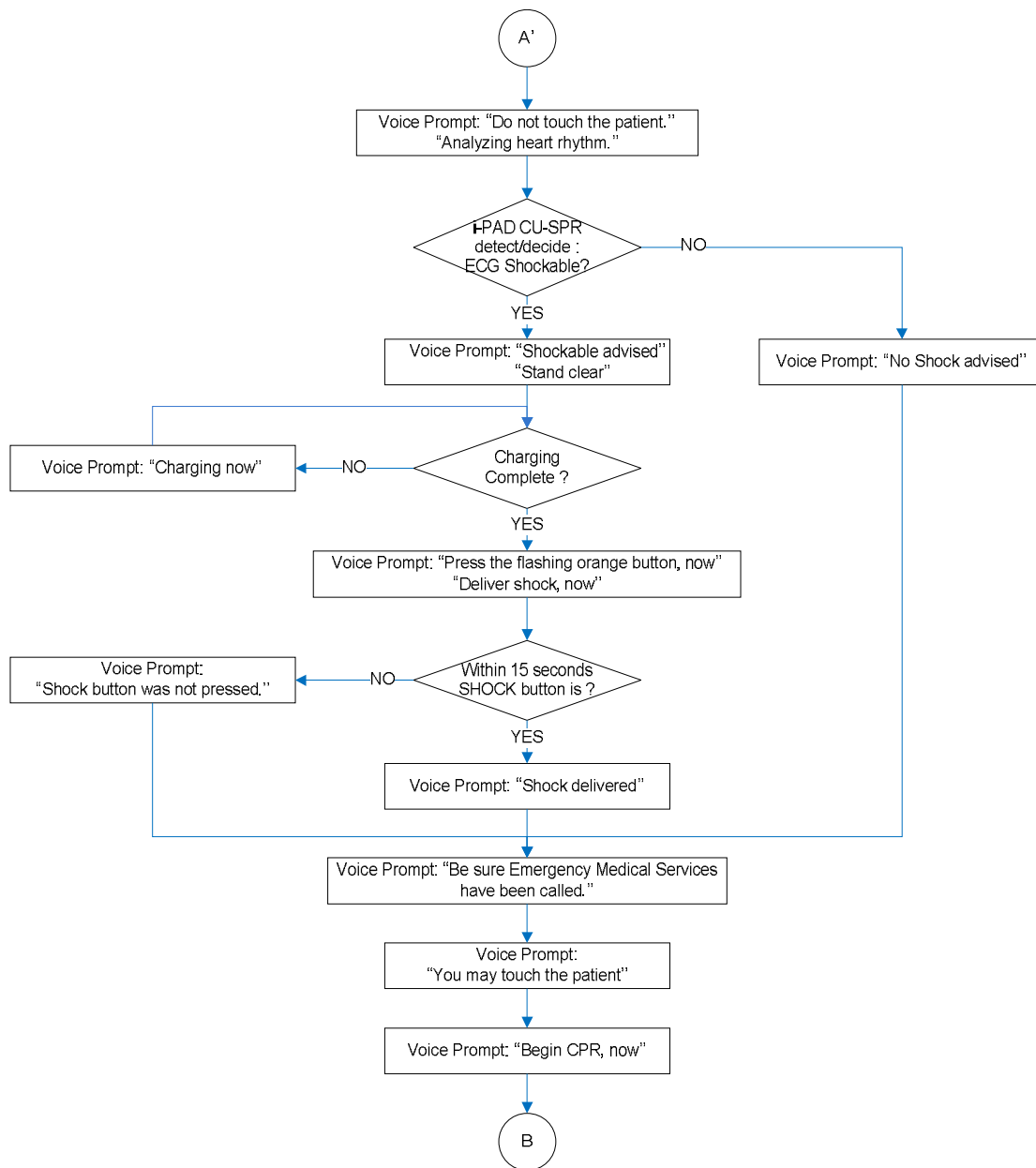

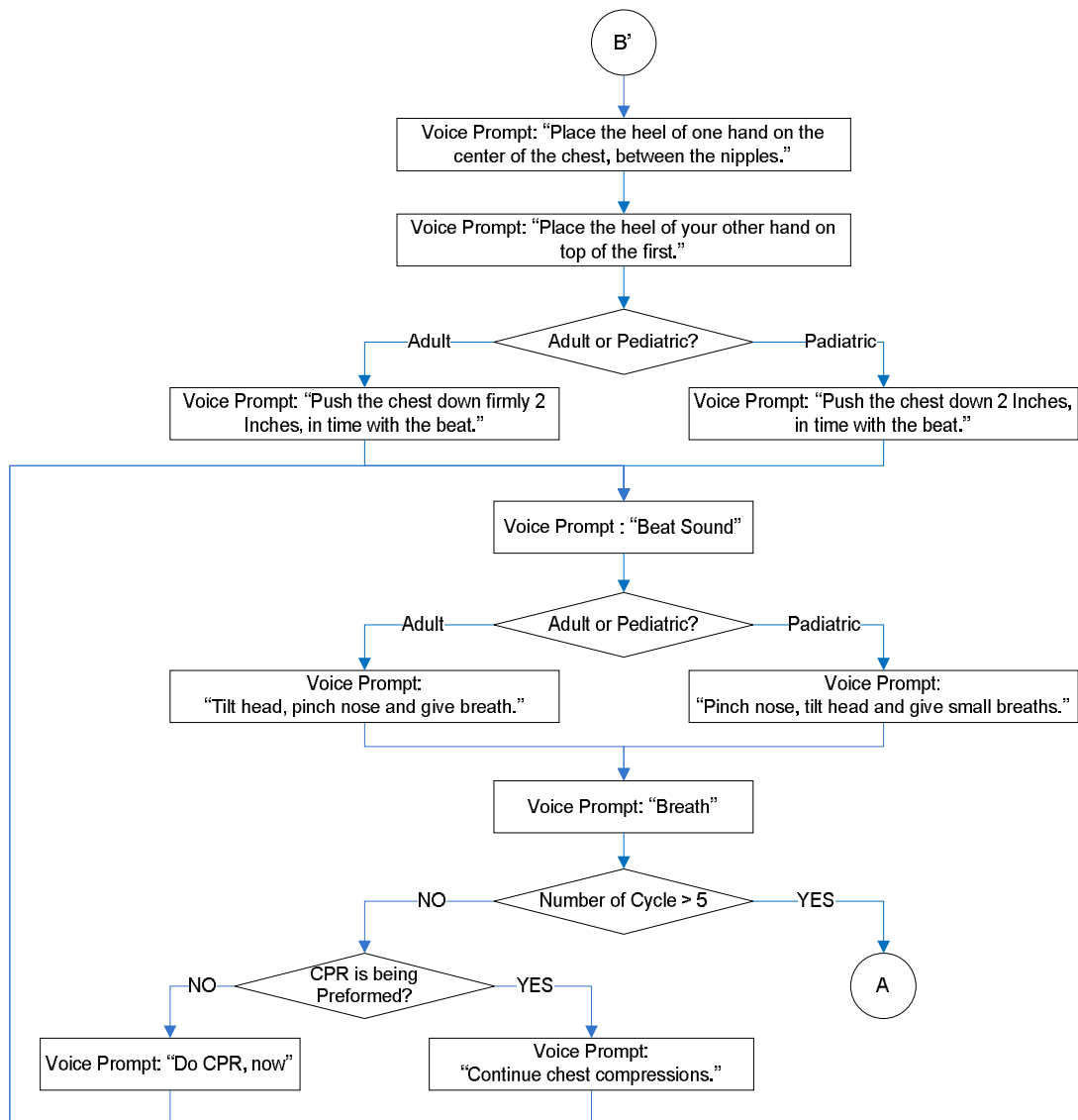

B . Parts and Accessories

To order replacement parts and accessories, cite the part and ordering numbers given in the following table.

B.1 Standard Accessories		
Name	Part Number	Ordering Number
Adult/Pediatric Pads (disposable)	CUA1904S	SPR-OA06
Disposable Battery Pack(Long-life)	CUSA2006BB	SPR-OA03
Instructions for Use	SPR-OPM-E-01	-
B.2 Optional Accessories		
Pediatric Pads (disposable)	CUA1102S	SP1-OA05
Carrying Case (Advanced)	SPR-A-BAG-3010	SPR-OA01
Carrying Case (Basic)	SPR-A-BAG-3020	SPR-OA08
Carrying Case (Fabric)	SPR-A-BAG-3030	SPR-OA09
Disposable Battery Pack(Standard)	CUSA2006BS	SPR-OA02
USB Storage	SPR-A-USB-4010	SPR-OA07
B.3 Other Options		
<p>Sealing: IEC 60529: IP68 (Basic Option: IP66)</p> <p>[Notification for Ingress Protection]</p> <ul style="list-style-type: none"> • The device is splash, water, and dust resistant and was tested under controlled laboratory conditions with a rating of IP68 under IEC standard 60529 (maximum depth of 1 meter up to 40 minutes). Splash, water, and dust resistance are not permanent conditions and resistance might decrease as a result of normal wear. Liquid damage not covered under warranty. • Do not press buttons or operate the product under water. • In case of contact with unclean water (salt, ionic water, or alcohol-containing water) wipe the device clean and dry completely with a soft cloth. Failure to do so may result in performance problems or appearance damage. • Do not dismantle or disassemble the product. Waterproof and dustproof performance may be impaired. • Do not drop the device and avoid any severe impact to it, otherwise the water and dust resistance of the device may be damaged. • If the device comes into contact with water at high temperature or high pressure, water might enter the device and damage it. 		

















- If the microphone, speaker, or buzzer of the device get wet with water, the device may not function properly. Resume use only after the device is completely dry inside.
- Do not remove the battery when your hands are wet. Water may enter the device and cause damage.
- Do not put the device in the water with the battery removed. The device is water and dust resistant only when the battery is properly inserted into the device.



















Be careful not to damage or contaminate the rubber seal attached to the device. The water and dust resistance features may be damaged when the rubber seal is damaged or foreign substances adhere to it.





The device can be damaged by being submerged in some situations.

C . Description of Symbols

Symbol	Description
	Power ON/OFF button
	SHOCK button
	Adult/pediatric mode selection button(i-Button)
	Early Access Instruction Indicator
	Do-Not-Touch-Patient Indicator
	Defibrillation Indicator
	CPR Detection Indicator
	CPR Cycle Indicator
	Stack up to 6 cartons high only
	This way up
	Keep dry
	Fragile; handle with care
	Use no hooks
	Storage Temperature limits: 0°C to 50°C(32°F to 122°F)
	Recyclable
	CE Mark

	CE Mark; meets the requirements of the European Medical Device Directive 2007/47/EC and its revisions.
	Serial Number
	Batch code
	Catalogue number
	Authorized representative in the European Community
	Date of manufacture
	Manufacturer
	Lithium Manganese Dioxide Battery
	Direct Current
	Do not break or apply pressure on the battery.
	Do not mutilate the battery or open the battery case.
	Do not charge.
	Do not expose the battery to high heat or open flames.
	Do not discard the battery indiscriminately. Discard in accordance with local regulations.
	Do not discard the battery indiscriminately. Discard in accordance with local regulations.
	Refer to instruction manual/booklet
	BF type, defibrillation-proof equipment
	Attention: Refer to accompanying documents.

	General warning sign
	Single use only; do not re-use
	Do not fold or bend.

D . Glossary

1 CPR	1 CPR consists of 5 cycles (When the device is set to 5 cycles as default).
1 Cycle	Refers to 30 chest compressions followed by 2 breaths during CPR. (When the device is set to the default setting [30:2])
Abrasive	A material used to sharpen and clean the surface of metal, glass, stone and wood, which includes emery, quartz powder and glass dust. Do not use these abrasives to clean the device.
Adhesive Material on the Pads (Gel)	The adhesive material on the pads is very important for maintaining the optimum adhesion between the skin and pads. Therefore, never open the pads package when the pads is not needed, and periodically check the expiration date of the pads.
Adult	Adult in these Instructions for Use is defined as a person who is older than 8 years or heavier than 25 kg.
American Heart Association (AHA) 2020 CPR Guidelines	The default settings of this device direct you to perform CPR immediately after electric shock in accordance with the 2020 CPR Guidelines. Also, the CPR guide is composed of 5 cycles with the chest compression to ventilation ratio of 30:2 (if the device is set to a default setting of 5 cycles, 30:2). If you are not trained in ventilation, perform only the chest compression. Please contact the manufacturer for additional information.
Arrhythmia	An abnormal heart rhythm.
Battery Pack	A disposable battery that supplies power to the CU-SPR.

Cardiac Arrest Patient	A patient with cardiac arrest symptoms. This device should be used for the patient with the following symptoms: No response, no movement and no normal breathing.
Condensation	Moisture has an adverse effect on the device when condensation is formed on the device surface. The device should be stored in a dry environment without excessive humidity.
CPR Mode	The device provides guidance for CPR while pausing analysis of the patient's ECG such that you can easily perform CPR. The CPR mode on this device complies with AHA's 2020 CPR Guidelines.
Defibrillation	This a process in which an electronic device gives an electric shock to the heart. This helps reestablish normal contraction rhythms in a heart having dangerous arrhythmia or in cardiac arrest.
Defibrillator Pads Connector	A connector on the device that is used to connect the device with defibrillator pads.
Disposable Battery Pack	A disposable battery pack that provides power to the device. Never charge this battery pack.
ECG	An abbreviation for electrocardiogram. A record of the heart's electrical rhythm as detected by the defibrillation pads.
Electric Shock	This device charges large energy in a short time and performs defibrillation via an electric shock.
Error	A status in which the device does not properly operate. Refer to [Section 8.3: Troubleshooting] for more information.
Fibrillation	Refers to an irregularity of the heart causing ineffective circulation. Ventricular fibrillation is accompanied with an acute cardiac arrest.

Flashing	A status in which the indicator is flashing.
Light	A status in which the indicator is lit.
Operation Mode	An  on the Status LCD while the device is on indicating that the device is properly operating.
Pads	The pads stated in these Instructions for Use refers to a pads (disposable) for defibrillation.
Pad 1	Refers to a pad that is placed under the right clavicle. Please refer to the picture on the pad (The position may be switched with pad 2).
Pad 2	Refers to a pad that is placed on the ribs on the patient's lower left chest directly under the armpit. Please refer to the picture on the pads (the position may be switched with pad 1).
Pads Connector	The connector on the pads that is used to connect the pads with the CU-SPR.
PC S/W CU Expert (CU-EX1)	PC software used to modify the settings of the CU-SPR and to manage treatment data. Refer to the appendix on accessories if you want to purchase this software.
Pediatric	The child in these Instructions for Use is defined as a person who is older than 1 year and younger than 8 years as well as lighter than 25 kg.
Power Button	A green button on the front of the device. The device turns on when the Power Button is pressed during Standby Mode, and it turns off when the Power Button is pressed for one second while the device is on. If the Power Button is pressed during the battery insertion test, the battery insertion test is canceled.
Device	The Device referred to in these Instructions for Use is the CU-SPR Semi-Automated External Defibrillator (AED).

Pads liner	The liner that protects the conductive gel of the pads during storage inside the pads pouch.
Self- Test	Self-diagnostic tests that verify the proper operation of the subsystems of the device.
Internal discharge (disarm)	The CU-SPR dumps the charge in its defibrillating capacitor into an internal load If you do not press the Shock Button or if the device determines that the patient does not need an electric shock due to the change in the patient's ECG.
Semi-Automated External Defibrillator (AED)	A device that delivers a defibrillating shock after analyzing and recognizing a shockable rhythm. You must concur with the shock delivery by pressing the SHOCK button.
Shock Button	The button that you must press to deliver an electric shock to a cardiac arrest patient.
Standby Mode	The mode of the CU-SPR when the Power Button is OFF but the battery pack is inserted. If  is shown on the Status LCD while the device is in standby mode, the device is ready to be used as needed in an emergency).
We	Refers to CU Medical Systems Inc.

E . Device Specifications

Model Name: CU-SPR

Physical

Category	Nominal Specifications
Dimensions	240mm x 230mm x 70mm (Width x Length x Height)
Weight	2kg (Including the battery pack and pads)

Environmental

Category Nominal Specifications

Operational Status (The device is in emergency use)

Temperature: 0°C ~ 50°C (32°F ~ 122°F)

Humidity: 5% ~ 95% (non-condensing)

Storage Status (The device is stored together with the defibrillator pads and the battery pack is inserted - ready to be used in an emergency)

Temperature: 0°C ~ 50°C (32°F ~ 122°F)

Humidity: 5% ~ 95% (non-condensing)

Transport Status (device only, no defibrillator pads and battery pack included)

Temperature: -20°C ~ 60°C (-4°F ~ 140°F)

Humidity: 5% ~ 95% (non-condensing)

Altitude 0 to 4,572 m (0 to 15,000 ft) - operational and storage

Drop Withstands 0.75meter drop to any edge, corner, or surface

Vibration Operating: Meets MIL-STD-810G Fig.514.6E-1, random
Standby: Meets MIL-STD-810G Fig.514.6E-2, swept sine(helicopter)

Sealing IEC 60529:2013 IP66

If you would like to purchase the optional IP68 device (CU-SPR), please refer to [Appendix B. Parts and Accessories] and contact us.

ESD Meets IEC 61000-4-2:2008

EMI (Radiated) Meets IEC 60601-1-2 limits, method EN 55011:2016+A1:2017,
Group 1,Class B

EMI (Immunity) Meets IEC 60601-1-2 limits, method EN 61000-4-3:2006 +A2:2010 Level 3
(10V/m 80MHz to 2.5GHz)

Defibrillator

Category	Nominal Specifications
Operating Mode	Semi-automated
Waveform	e-cube biphasic (Truncated exponential type)
Output Energy	150/200 J at 50 Ω load for adults 50 J at 50 Ω load for pediatric
Charge Control	Controlled by an automated patient analysis system
Charging Time	Within 3 seconds from when the voice instruction, "An electric shock is needed." is issued. Time from initiation of rhythm analysis <ul style="list-style-type: none">- 10 seconds with a new battery(even after the delivery of 15 discharges at 150J)- 12 seconds with a new battery(even after the delivery of 15 discharges at 200J) Time from Power on to readiness for discharge <ul style="list-style-type: none">- 25 seconds with a new-fully charged battery(even after the delivery of 15 discharges at maximum energy) (Charging Time varies depending on the language, and the charging time listed is based on an English voice prompt.)
Charging Indicator	<ul style="list-style-type: none">• Voice Instruction "Press the Flashing Orange Button, Now. Deliver Shock, Now"• Flashing Shock Button• Beeper
Time from CPR to Shock	At least 6 seconds from the completion of CPR to shock delivery
Discharge	The device performs a self-discharge in the following events: <ul style="list-style-type: none">• When the patient's ECG changes to a rhythm that does not require defibrillation.• When the Shock Button is not pressed within 15 seconds from the completion of the charge.• When the device is turned off by pressing the Power Button for at least second.• When the pads is detached from the patient's body or the pads connector is detached from the device.• When the impedance of the patient is out of the range of defibrillation (25 Ω ~ 175 Ω)
Shock Delivery	Shock is delivered if the SHOCK button is pressed while the CU-SPR is armed.
Shock Delivery Vector	<ul style="list-style-type: none">• Adult pads in the anterior-lateral position• Pediatric pads in the anterior-posterior position

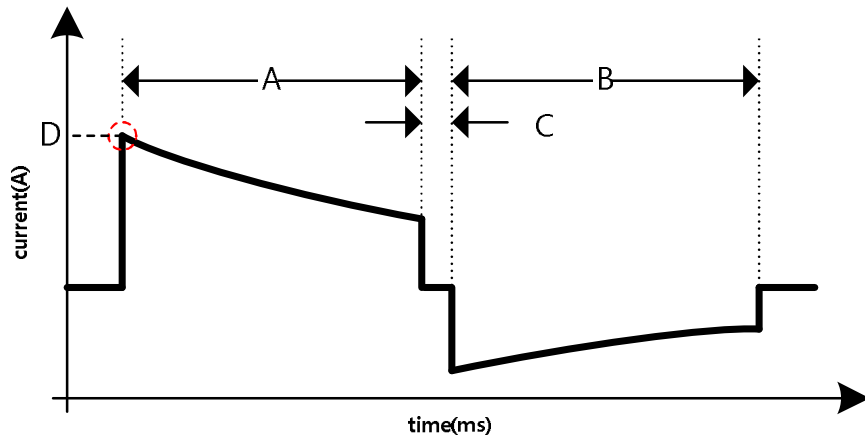

Biphasic Truncated Exponential Type.

The shock waveform profile is automatically compensated for the patient's transthoracic impedance.

- A = first phase duration
- B = second phase duration
- C = interphase duration
- D = peak current

Output Waveform for Adult (200 Joules)

Patient Impedance (Ohms, Ω)	First Phase duration (milliseconds, ms)	Second Phase duration (milliseconds, ms)	Peak Current (A)	Energy (Joules, J)	Energy Accuracy (Joules, J)
25	2.4	2.4	70.5	201.0	200(±15%)
50	4.4	4.4	35.6	200.7	200(±15%)
75	6.5	6.5	25	203.0	200(±15%)
100	8.8	8.8	18.9	204.0	200(±15%)
125	10.7	10.7	15.09	202.6	200(±15%)
150	12.7	12.7	12.81	203.8	200(±15%)
175	14.8	14.8	11.15	204.7	200(±15%)

Output Waveform for Adult (150 Joules)

Patient Impedance (Ohms, Ω)	First Phase duration (milliseconds, ms)	Second Phase duration (milliseconds, ms)	Peak Current (A)	Energy (Joules, J)	Energy Accuracy (Joules, J)
25	2.4	2.4	64.5	147.8	150(±15%)
50	4.4	4.4	32.7	149.7	150(±15%)
75	6.3	6.3	22.5	151.5	150(±15%)
100	8.8	8.8	15.9	148.1	150(±15%)
125	10.7	10.7	13.0	149.0	150(±15%)
150	12.7	12.7	11.0	148.2	150(±15%)
175	15.0	15.0	9.5	148.8	150(±15%)

Output Waveform for Pediatric (50 Joules)

Patient Impedance (Ohms, Ω)	First Phase duration (milliseconds, ms)	Second Phase duration (milliseconds, ms)	Peak Current (A)	Energy (Joules, J)	Energy Accuracy (Joules, J)
25	2.3	2.3	35.4	50.2	50(\pm 15%)
50	4.3	4.3	18.4	50.7	50(\pm 15%)
75	6.3	6.3	12.3	49.7	50(\pm 15%)
100	8.5	8.5	9.1	49.5	50(\pm 15%)
125	10.6	10.6	7.3	50.3	50(\pm 15%)
150	12.7	12.7	5.8	49.0	50(\pm 15%)
175	15.0	15.0	4.9	49.6	50(\pm 15%)

ECG Acquisition

Category	Nominal Specifications
Acquired ECG Lead	Lead II
Frequency Response	1 Hz to 30 Hz

ECG Analysis System

Category	General Specifications
Function	Analyzes whether the rhythms of the patient's impedance and ECG require a defibrillation
Measured Impedance Range	25 Ω ~ 175 Ω
Rhythm Requiring Defibrillation	<ul style="list-style-type: none"> Ventricular fibrillation and several ventricular tachycardia (more than 150bpm for adult and 200bpm for pediatric) including ventricular flutter. (Ventricular Fibrillation and rapid Ventricular Tachycardia) The CU-SPR uses multiple variables to determine the shockability of the heartbeat. Some extremely low amplitudes or low frequency heartbeats are not interpreted as shockable VF beats. Also, some VT beats are not interpreted as rhythms requiring defibrillation.
Rhythm Not Requiring Defibrillation	<ul style="list-style-type: none"> ECG rhythms excluding those requiring a defibrillation

- When a rhythm that does not require a defibrillation is detected, the device informs the user by voice to perform CPR.

Analysis Protocol Prepares to administer shock or give voice instructions on CPR according to the analysis result

Algorithm sensitivity and specifications that require defibrillation Satisfies AAMI DF39

ECG Analysis System - ECG Database Test

ECG Rhythm Class	Rhythms	Minimum test sample size	Performance goal	Test sample size	Shock Decision	No Shock Decision	Observed Performance	90% One Sided Lower Confidence Limit
SHOCKABLE	coarse VF	200	>90% sensitivity	219	213	6	97.26% (213/219) sensitivity	95%
	rapid VT	50	>75% sensitivity	137	111	26	81.02% (111/137) sensitivity	76%
NON SHOCKABLE	Normal Sinus Rhythm	100 minimum (arbitrary)	> 99% specificity	100	0	100	100% (100/100) specificity	97%
	AF,SB,SVT, heart block, idioventricular PVC's	30 (arbitrary)	> 95% specificity	219	1	218	99.54% (218/219) specificity	98%
	Asystole	100	> 95% specificity	132	5	127	96.21% (127/132) specificity	93%

- a. A Statement for Health Professionals from the AHA (American Heart Association) Task Force on AED, Subcommittee on AED Safety and Efficacy. Automatic External Defibrillators for Public Access Defibrillation: Recommendations for Specifying and Reporting Arrhythmia Analysis Algorithm Performance, Incorporating New Waveforms, and Enhancing Safety. Published 1997; 95:1677-1682.
- b. According to AHA Recommendations (a) and AAMI-based DF39, SVT is clearly included in the non-shockable rhythm grade.

Control Devices, Indicators, Voice Instructions

Category	General Specifications
Control Devices	Power Button, Shock Button, Adult/Pediatric Mode Selection Button
Status LCD	Displays device status, battery level and pads status.
Status LED	Displays device status, battery level and pads status.
Indicator	<p>Do-Not-Touch-Patient Indicator: Lights when the defibrillator is analyzing or delivering an electric shock.</p> <p>Pads Patch Position Indicators: Flashes when the defibrillator is turned on; turns off when the pads is attached on the patient.</p> <p>Status LED Indicator:</p> <p>Operation Mode: When the defibrillator is turned on, if the pads connector is no connected, the status LED flashes orange once, and the pads connector is connected, the status LED flashes green.</p> <p>Standby Mode: If the device has an error in standby mode, the status LED flashes red once when the status LED indicates X.</p> <p>CPR Detection Indicator: Lights if CPR is detected; flashes if CPR is not detected.</p> <p>Shock Button: Flashes orange when the defibrillator is charged and ready to deliver a shock.</p>
Speaker	Plays back voice instructions. The CU-SPR analyzes the ambient noise level during a treatment operation. If ambient noise level is high, it automatically increases the voice instructions volume so that you can hear them clearly.
Sound pressure	80dB ~ 90dB (± 3 dB), apart 1m above speaker
Beeper	Various beeping output
Battery Level	The battery level is automatically checked during periodic self-tests, power ON self-test, and run-time self-test.
Low Battery Indicator	Shown on the Status LCD and the Status LED, announced via voice instruction When the device detects Low Battery after normal defibrillation sequence, it warrants 10 shocks and 30 minutes of operation.
Voice Instruction	Guides the user via voice instructions.

Self-Diagnostic Test

Auto	<ul style="list-style-type: none">• Power On Self-Test, Run-time Self-Test• Daily, Weekly, and Monthly Self-Test
Manual	Battery Pack Insertion Test (done when the user inserts the battery pack into the battery pack compartment of the device)

Disposable Battery Pack (CUSA2006BB)

Category	Nominal Specifications
Battery Type	12V DC, 4.2Ah LiMnO ₂ , Disposable: Long Life
Capacity	150 Joules - At least 200 shocks for a new battery or 8 hours of operating time at room temperature 200 Joules - At least 150 shocks for a new battery or 6 hours of operating time at room temperature
Standby Life (After Inserting the Battery)	At least 5 years from the date of manufacture if stored and maintained in accordance with the instructions in this document.
Temperature Ranges	<ul style="list-style-type: none">• Operating Temperature: 0°C ~ 50°C (32°F ~ 122°F)• Storage Temperature: -20°C ~ 60°C (-4°F ~ 140°F)

Defibrillation Adult/Pediatric Pads (CUA1904S)

Category	Nominal Specifications
Type	Adult
Electrode Area	85 cm ²
Cable Length	Total 120 cm (Inside the pouch: 95 cm, Outside the pouch: 25 cm)
Shelf Life	At least 36 months from the date of manufacture

Defibrillation Pediatric Pads (CUA1102S)

Category	Nominal Specifications
Type	Pediatric
Electrode Area	85 cm ²
Cable Length	Total 120 cm (Inside the pouch: 95 cm, Outside the pouch: 25 cm)
Shelf Life	At least 30 months from the date of manufacture

Disposable Battery Pack (CUSA2006BS)

Category	Nominal Specifications
Battery Type	12V DC, 2.8Ah LiMnO ₂ , Disposable: Standard Life
Capacity	150 Joules - At least 50 shocks for a new battery or 3 hours of operating time at room temperature 200 Joules - At least 40 shocks for a new battery or 2 hours of operating time at room temperature
Standby Life (After Inserting the Battery)	At least 2 years from the date of manufacture if stored and maintained in accordance with the instructions in this document.
Temperature Ranges	<ul style="list-style-type: none">• Operating Temperature: 0°C ~ 50°C (32°F ~ 122°F)• Storage Temperature: -20°C ~ 60°C (-4°F ~ 140°F)

Data Storage and Transfer

Category	Nominal Specifications
Internal Memory Data Capacity	5 individual treatments, up to 3 hours per treatment
USB Memory	External memory. Data may be copied from the internal memory to the USB.
File System	FAT32

F . Electromagnetic Compatibility

Guidance and manufacturer's declaration

The CU-SPR is intended for use in the electromagnetic environment specified below. The customer or the user of the CU-SPR should assure that it is used in such an environment.

Emissions test	Compliance level	Remark
Radiated disturbance CISPR 11:2015+A1:2016	Group1 Class B	-

Immunity	Test Method	Compliance level	Remark
Electrostatic Discharge Immunity (ESD)	IEC 61000-4-2	±8kV / Contact ±2, ±4, ±8, ±15 kV / Air	-
Radiated RF Electromagnetic Field Immunity	IEC 61000-4-3	20 V/m 80MHz – 2.7 GHz 80% AM at 1 kHz, 5 Hz	-
Immunity to Proximity Fields from RF wireless Communications Equipment	IEC 61000-4-3	Table 9 in IEC 60601-1-2:2014	-
Conducted disturbances induced by RF Fields	IEC 61000-4-6	3Vrms 150kHz to 80 MHz 80% AM at 5 Hz 6Vrms in ISM and amateur radio bands between 0.15MHz and 80 MHz	-
Power Frequency Magnetic Field Immunity	IEC 61000-4-8	30 A/m 50 Hz and 60 Hz	-

 WARNING

- The CU-SPR should not be used adjacent to or stacked with other equipment. If adjacent or stacked use is necessary, the CU-SPR should be observed to verify normal operation in the configuration in which it will be used.
 - Use of this equipment adjacent to or stacked with other equipment should be avoided because it could result in improper operation. If such use is necessary, this equipment and the other equipment should be observed to verify that they are operating normally.
 - Portable RF communications equipment (including peripherals such as antenna cable and external antennas) should be used no closer than 30 cm (12 inches) to any part of the CU-SPR, including cables specified by the CU Medical Systems, Inc. Otherwise, degradation of the performance of this equipment could result.
-



Medical Systems, Inc.